

2460.4 Stainless Steel Wallcovering

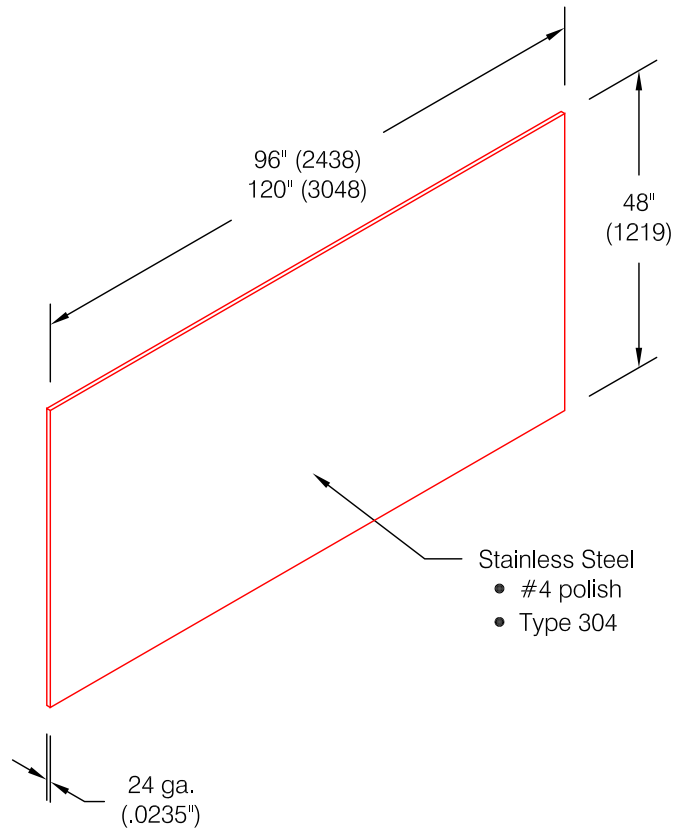

Features:

- Type 304
- 24 gauge
- Standard sizes:
 - 4'-0" (1219) x 8'-0" (2438)
 - 4'-0" (1219) x 10'-0" (3048)
- Other thickness available
- Custom sizes are available (minimums apply)

Finishes:

- #4 polish

Mounting Options:

- Standard mounting
- Adhesive:
 - ADH-50 adhesive supplied separately
- Optional mounting
- Drilled:
 - Clearance holes for ABSS-113 #8 x 1 1/2" oval head sheet metal and ABCW-132 stainless cup washer supplied separately as required
- Countersink Drilled:
 - Clearance holes for ABSS-134 #6 x 1 1/2" oval head sheet metal screw supplied separately as required

Optional Accessories:

- Profile edge trim (24 gauge)
(See below)

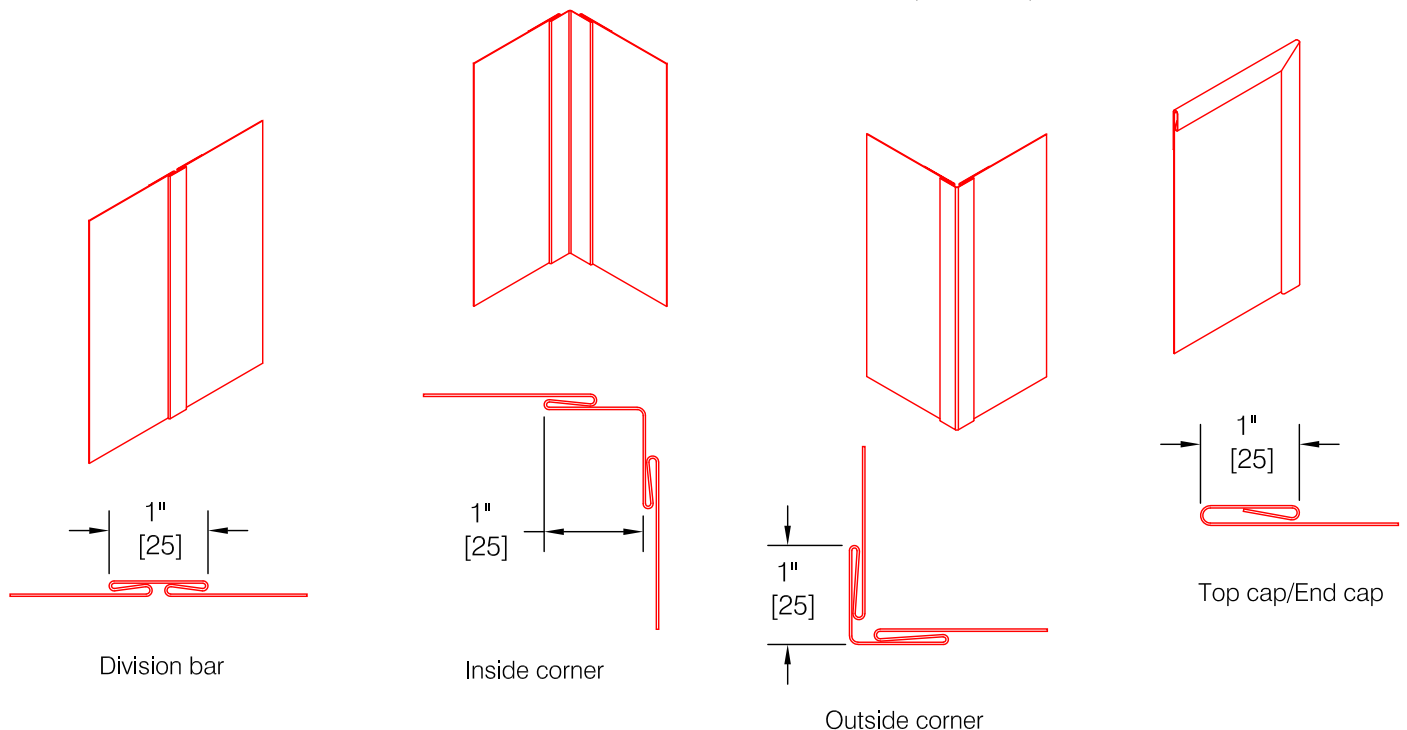

WallGuard.Com reserves the right to discontinue a design or modify an existing design without prior notice