

New Frontier Series

Wall Covering Installation Instructions

About The Installation

Properly installed, your New Frontier Series wall covering will yield years of dependable service.

Proper installation is critical to the aesthetic appeal of the finished product.

After studying this installation guidebook, a mechanically inclined person will be capable of installing the wall covering.

The installation process requires a person capable of:

- reading and understanding the installation booklet.
- working at a steady, determined pace.
- using power and hand tools.
- working with adhesives.

Although the installation process seems daunting to many at first, it will prove elementary to the capable person who takes their time understanding and then implementing the installation process.

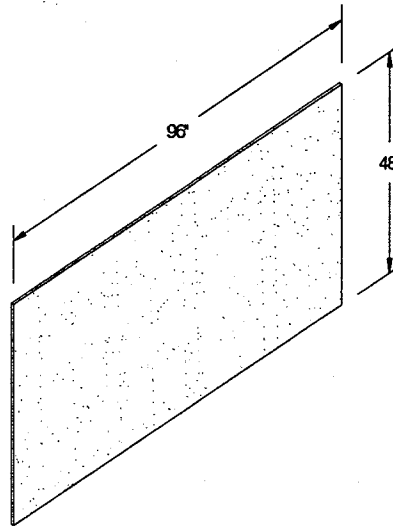

Standard New Frontier Series Sheet

We have found that for most installations 2 installers can hang approximately 16 sheets in an 8 hour day.

See all that WallGuard.com has to offer

Visit us on the web at www.wallguard.com to see our full line of architectural impact protection products.

From pedestrian traffic and gurneys to fork lifts and tractor trailers, WallGuard.com has the product to protect your walls.

We manufacture products in vinyl, aluminum, rubber, stainless steel, wood, and

urethane. Contact us to solve any impact protection problem you have.

Our business model affords our customers the highest quality products on the market at the lowest possible prices.

Forget the rest...work with the best;

wallguard.com

Table of Contents

<i>General Information</i>	2
<i>Project Preparation</i>	3
<i>Tools Required</i>	4
<i>Contact Adhesives</i>	5
<i>Mastic Adhesives</i>	6
<i>Accessories</i>	7,8
<i>Care and Cleaning</i>	9
<i>Warranty</i>	9
<i>Tech Sheet</i>	10
<i>Fax back Form</i>	11
<i>Other Products</i>	12

Our Other Products Include:

- *Handrails*
- *Corner Guards*
- *Wall Guards*
- *Door Protection*

©Copyright 2002
WallGuard.com, LLC

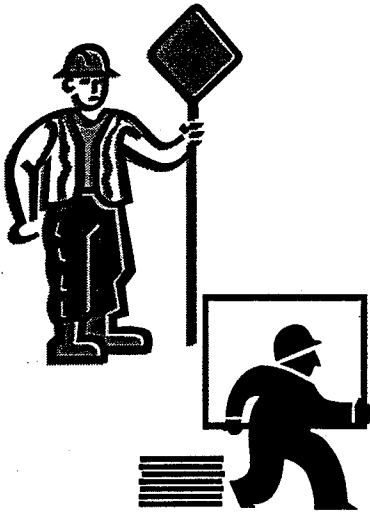

IMPORTANT: Our vinyl wall covering is a non-reinforced, semi-rigid, thermoplastic product that may be subject to dimensional changes (i.e., expansion or contraction) with temperature fluctuations. There is a tolerance of 1/32" per foot on diagonal for all sheet sizes. Follow this installation manual precisely for best results.

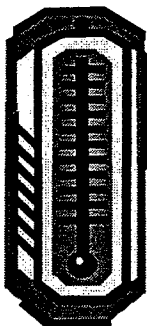

General Installation Information

STORAGE

Wall covering sheets must be stored flat in the original packaging. Do not stand sheets on end or store other material on top of them. Rolls must be stored in the original packaging; do not stack rolls or store other material on top of the rolls. Store in a clean dry place where the temperature is maintained above 50°F (10°C).

BEFORE INSTALLATION

The temperature of the walls and the rooms should be maintained at a minimum of 65°F (18°C) for at least 48 hours prior to installation. Allow wall covering and all adhesive to acclimate for at least 24 hours at a minimum temperature of 65°F (18°C) but no more than 85°F (29°C) before beginning the installation process. Place wall covering sheets on a clean, flat surface and weight the corners for at least 24 hours to reduce the possibility of curl and to relax the vinyl. Unroll wall covering rolls and allow to lie flat for at least 24 hours. Wipe the back of the vinyl with a damp rag to remove any dust and allow to dry thoroughly.

DURING INSTALLATION

Maintain a constant temperature and environment while installing wall covering. Temperature for the application surface and the room should be maintained at a minimum of 65°F (18°C) and a maximum of 85°F (29°C), with the preferred temperature being 75°F (24°C) during installation. If relative humidity is greater than 80%, do not install wall covering because high humidity can significantly lengthen the curing time of adhesives. Don't install wall covering near heating vents, radiators, etc. or in direct sunlight; resulting expansion and contraction can cause distortion blistering, etc.

CUTTING WALLCOVERING

Thinner gauges (.030" and .040") can be cut with a utility knife. Use a metal straight edge as a guide and make several passes with the knife blade along the line to be cut. Thicker gauges (.060" and above) can be cut by scribing with a Plexiglass acrylic sheet cutting tool and breaking. Use a metal straight edge as a guide and make several passes with the cutting tool along the line to be cut. For best results place the scribed edge over a 3/4" diameter dowel and apply downward hand pressure on both sides of the scribed line.

Wall covering can also be cut using most common types of power sawing equipment, including circular saws, jigsaws, and saber saws. Circular saws are used for straight cuts; jig and saber saws are used for cutting small radii curves. Use standard blades designed for cutting plywood; these are preferred over carbide-tipped blades when cutting thin gauges of wall covering.

DRILLING WALLCOVERING

Holes may be drilled in vinyl wall covering with standard, high speed drills operated over a wide range of speeds as long as feeds are not forced. Use of a brad point wood bit will produce the cleanest shaped hole.

ROUTING WALLCOVERING

Portable routers may be used for cutting vinyl to size. Usually a wood jig is constructed on site into which the vinyl wall covering is placed, measured, marked, and cut using the portable router.

AFTER INSTALLATION

Don't expose walls to elevated temperatures or direct sunlight as this can result in wall surface temperatures in excess of 100°F (38°C) which can cause blistering and distortion of wall covering.

Surface Preparation

- 1 Remove any pre-existing wall covering. For best results walls must be resurfaced if damaged.
- 2 Remove any rough spots by sanding walls until smooth.
- 3 Test for paint adhesion. Use a razor to score the surface of a 12" square area in grid pattern. Try to remove the broken paint film by applying cellophane or masking tape; pull off sharply. If the paint comes off, the wall must be stripped prior to installation.
- 4 Prime unfinished surfaces with latex primer.
- 5 Before applying adhesive, the walls and wall covering sheets must be completely free of grease, dirt, etc. Wipe surfaces with a clean water-dampened rag to remove any dirt or debris.

Dry Fitting Sheets

- 1 Use a chalk line or masking tape to outline the area to be covered. If installing as wainscoting, make sure the sight line at the top edge is level. On full wall installation the vertical edge must be plumb.
- 2 For consistent appearance, install sheets with the "Windrift" texture running in the same direction. This is indicated by arrows printed on the back side of each sheet.
- 3 Wall covering must have a 1/16" (1.6mm) expansion gap between sheets.
- 4 Do not butt wall covering up against door jambs, ceilings, or baseboards. Leave a 1/16" (1.6mm) expansion clearance.
- 5 For recommendations on installing joint cover, inside and/or outside corner, or top cap moldings, etc., see page 7.
- 6 An expansion clearance of at least 1/8" (3.2mm) must be allowed on all four sides of the sheets on interior surfaces of perimeter walls and any area subject to temperature variations to permit natural dimensional change.
- 7 When installing fixtures such as handrails, air ducts, etc., oversized holes must be drilled due to the natural expansion and contraction of the sheet as temperature changes occur. Accessories such as caulk or moldings can be used to minimize the visual effect of large openings.
- 8 Check the surface that the wall covering will be applied to for squareness. Check all wall covering sheets for squareness; there is a tolerance of 1/32" per foot on diagonal on all sheets.

Be certain that substrate is painted or sealed using latex primer before applying contact adhesive. Newly sealed walls must be completely dry prior to application of contact adhesive.



Read and follow all of the temperature, storage/handling information and installation instructions completely for optimum final results.

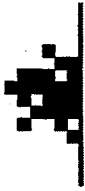

NOTE: The use of mastic adhesive when installing either 0.040" roll material or wall covering sheets with a thickness of over 0.060" is NOT recommended

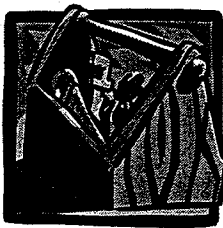

For help determining which adhesive is right for you, call a technical representative at 877-943-6826.



Tools and Adhesive

To ensure proper installation, make sure that you choose the appropriate tools and adhesive for your surface conditions.

Be sure to follow manufacturer's instructions for proper adhesive use and application, including all storage and temperature recommendations. WallGuard.com recommends using either Super Tek XT-2000 mastic adhesive or 3M Fastbond 30 contact adhesive.

Maintain adequate ventilation when working with adhesives and/or cleaning products.

Keep tools clean and in good working condition at all times.

Tools for Mastic Adhesive

(bonds after 20-30 minutes)

- Notched trowel (use 1/16" square notch for smooth walls or 1/8" U-notch trowel for rough walls)
- Super Tek XT-2000 mastic adhesive
- Mason's stone for rough surfaces
- Chalk line/plumb bob
- Block plane or scraper
- Heavy-duty razor knife for thin gauge vinyl or Plexiglass acrylic sheet cutter for .060" gauge and above
- Straight edge
- 3/4" dowel (for breaking scored lines)
- Sabre saw
- Hand-held circular saw
- Putty knife
- Heavy-duty pressure roller, such as a Crain #333 extension roller or equivalent

Tools for Contact Adhesive

(bonds instantly)

- Short nap paint roller & tray
- Trim brush
- 3M Fastbond 30 contact adhesive
- Chalk line/plumb bob
- Sanding block
- Heavy-duty razor knife for thin gauge vinyl or Plexiglass acrylic sheet cutter for .060" gauge and above
- Straightedge
- 3/4" dowel (for breaking scored lines)
- Sabre saw
- Hand-held circular saw
- Putty knife
- Polyethylene (4-8 mil) Kraft paper or scrap vinyl wall covering to act as slip sheeting (place between wall covering and contact adhesive as you position sheet above adhesive; pull out as you place sheet on adhesive)
- Stiff paperhanger brush
- Heavy-duty pressure roller, such as a Crain #333 extension roller or equivalent

Applying Contact Adhesive

- 1 Follow all of the adhesive manufacturer's recommended safety precautions, such as providing adequate ventilation, etc.
- 2 Stir adhesive thoroughly before beginning.
- 3 Apply two coats of contact adhesive to the wall using a short nap roller; allow the first coat to dry completely before applying the second coat. Use a trim brush to cut in any corners.
- 4 Apply one coat of adhesive to the back (smooth) side of the sheet of wall covering using a short nap roller.
- 5 To ensure evenness in the adhesive film, avoid excessive rolling or re-rolling. Avoid puddles or dry spots.
- 6 Wait for 2-1/2 to 3 hours. After adhesive dries, 3 hours remain to complete the bonding. **THE LONGER YOU WAIT (UP TO 4 HOURS TOTAL) THE STRONGER THE INITIAL BOND WILL BE.** The adhesive color darkens as it becomes dry. Do not install wall covering until all wet spots have disappeared. You must re-coat the wall covering and the walls with adhesive if sheet is not installed within 4 hours.
- 7 Dry adhesive should have a glossy film. Dull spots after drying indicate insufficient adhesive; these spots must be re-coated.

Installing Sheets

- 1 Align the edge of the vinyl wall covering sheet with a chalk or tape line. (It is recommended that roll material be cut into sheets 12' long maximum for .030" gauge and 10' long maximum for .040" gauge to avoid excess twisting and additional thermal expansion/contraction problems. Lay all cut sheets flat and weight the corners for at least 24 hours prior to installation.)
- 2 Carefully remove the slip sheet while smoothing the wall covering sheet into place using a stiff paperhanger brush.
- 3 Immediately roll the entire surface of the sheet with a heavy-duty pressure roller, such as a Crain #333 extension roller or the equivalent. Begin rolling in the center of the sheet and work outwards to the edges. **THE INSTALLER MUST APPLY HEAVY PRESSURE WHILE ROLLING TO PREVENT ANY AIR POCKETS FROM FORMING UNDER THE SURFACE.** Roll every sheet completely out to all of the edges.
- 4 **During and after installation, remove any excess adhesive on the front of vinyl wall covering sheets immediately. FOLLOW THE DIRECTIONS FROM THE ADHESIVE MANUFACTURER FOR REMOVING EXCESS ADHESIVE.** Do not allow adhesive to dry on surface of wall covering or tools. Use clean rags to avoid re-depositing adhesive residue on wall covering. A solvent such as naphtha or mineral spirits may be used. For additional cleaning recommendations, see page 9.

Be certain that substrate is painted or sealed using latex primer before applying contact adhesive. Newly sealed walls must be completely dry prior to application of contact adhesive.



Because contact adhesive will bond to itself immediately upon contact, use of slip sheets is strongly recommended to prevent accidental bonding.

Be certain that substrate is painted or sealed using latex primer before applying contact adhesive. Newly sealed walls must be completely dry prior to application of contact adhesive.



During and after installation, remove any excess adhesive on the front of vinyl wall covering sheets immediately.

Applying Mastic Adhesive

- 1 Follow all of the adhesive manufacturer's recommended safety precautions, such as providing adequate ventilation, etc.
- 2 Apply mastic adhesive only to the wall surfaces. Don't apply adhesive to the wall covering. Don't let adhesive dry on tools or materials; keep trowel grooves clean while working by washing frequently.
- 3 Spread the adhesive evenly onto the walls with a notched trowel only, making sure to cover the surface area completely. To adhere .030" gauge wall covering to smooth walls use a 1/16" square-notched trowel to apply adhesive. Use a 1/8" deep u-notched trowel to apply adhesive to rough walls. For all other gauges of wall covering, use a 1/8" deep u-notched trowel. Make sure you achieve 100% surface coverage on all walls with an even coat; using an insufficient amount of adhesive is the cause of most installation problems.
- 4 Allow mastic approximately 20-30 minutes to dry before installing wall covering. The adhesive should start to become firm to the touch; this increases the initial tack and helps reduce telegraphing of bulges.
- 5 For non-porous substrates such as painted metal, stainless steel, etc., let mastic dry for a minimum of one hour but not longer than three hours. The change in color of the adhesive from white to clear signifies the optimum time for adhering the wall covering.

Installing Sheets

- 1 Align the edge of the wall covering sheet with a chalk or tape line. (It is recommended that roll material be cut into sheets 12' long maximum for .030" gauge and 10' long maximum for .040" gauge to avoid excess twisting and additional thermal expansion/contraction problems. Lay all cut sheets flat and weight the corners for at least 24 hours prior to installation.)
- 2 Place the sheet on the wall and smooth it into place by hand. DO NOT allow vinyl wall covering sheet to touch adhesive unless it is completely aligned or the installer may be unable to re-adjust the sheets properly.
- 3 Immediately roll the entire surface of the sheet with a heavy-duty pressure roller such as a Crain #333 extension roller or the equivalent. Begin rolling in the center of the sheet and work outwards to the edges. THE INSTALLER MUST APPLY HEAVY PRESSURE WHILE ROLLING TO PREVENT ANY AIR POCKETS FROM FORMING UNDER THE SURFACE. Roll sheets completely out to all of the edges.
- 4 FOLLOW THE DIRECTIONS FROM THE ADHESIVE MANUFACTURER FOR REMOVING EXCESS ADHESIVE. Do not allow adhesive to dry on surface of wall covering or tools. Use clean rags to avoid redepositing adhesive residue on wall covering. Dry adhesives can sometimes be removed with naphtha or mineral spirits. For additional cleaning recommendations, see page 9.

Accessory Molding Installation

The temperature of the walls and the rooms should be maintained at a minimum of 65°F (18°C) and a maximum of 85°F (20°C) for proper installation.

Cut moldings with a common power saw with standard blades designed for cutting plywood, or use carbide tipped blades. When planning the job leave allowances for intersecting moldings (for example, where a top cap molding meets a joint cover).

USING MASTIC ADHESIVE: You don't need to apply additional adhesive to the back side of the moldings; the adhesive troweled onto the wall is sufficient.

USING CONTACT ADHESIVE: Use a small trim brush and apply one coat of contact adhesive to the back side of moldings and allow to dry according to manufacturer's instructions. Do not allow adhesive to contact visible surface of moldings.

TOP CAP

Slip the top cap molding over the edge of the vinyl wall covering prior to using the high-pressure roller. The molding is trapped between the wall covering and the substrate. Immediately after installing the top cap molding use the high-pressure roller to roll all surfaces and edges of wall covering.

JOINT COVER

After the first sheet of wall covering has been installed put the channel of the joint cover onto one side of the sheet being installed on the intersecting wall and install the second sheet next to the first sheet with the free leg of the joint cover overlapping the previously installed sheet. Leave a 1/16" gap within the molding to allow for sheet expansion. Install successive sheets in similar manner

INSIDE CORNER

After the first sheet of wall covering has been installed, leave a 1/16" gap at the interior corner. Put the channel of the inside corner onto one side of the sheet being installed on the intersecting wall and install this sheet with the corner molding overlapping the previously installed sheet. Leave a 1/16" gap within the molding to allow for sheet expansion.

OUTSIDE CORNER

After the first sheet of wall covering has been installed put the channel of the outside corner onto one side of the sheet being installed on the intersecting wall and install this sheet with the molding overlapping the previously installed sheet. Leave a 1/16" gap within the molding to allow for sheet expansion.

CAULK

Color matched caulk is an acrylic based evaporative cure sealant with a special silicone modifier that is color matched to our vinyl wall covering. Caulk provides a waterproof seam when applied properly. Caulk allows for the normal thermal expansion of wall covering. It will darken to color match as it dries. Tooling is recommended to ensure positive contact with joint surfaces. A 10.5 oz. tube covers approx. 150 linear feet. Joint dimension should not exceed 3/8" x 3/8". Remove unwanted caulk immediately from wall covering surfaces and tools with soapy water.

Accessories

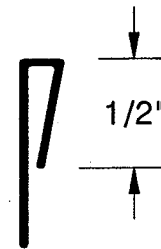

TOP CAP



INSIDE CORNER

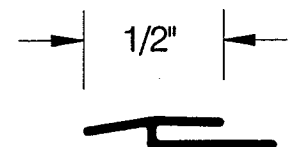

JOINT COVER

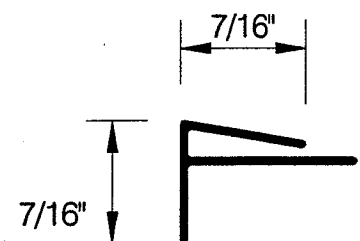

OUTSIDE CORNER



Corner Guard

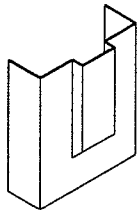
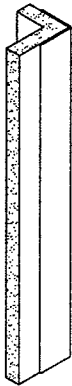

Door Frame Protection

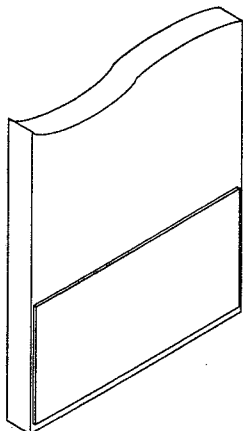

Kick Plates

Accessory Installation Information

The temperature of the walls and the rooms should be maintained at a minimum of 65°F (18°C) and a maximum of 85°F (20°C) for proper installation.

Be sure of the compatibility of adhesives with various surfaces before beginning. Follow all adhesive manufacturer's recommended safety precautions, such as providing adequate ventilation, etc. Be sure all adhesive is stirred thoroughly before applying to surface.

Prepare the area properly. Wipe the wall surface and the back of the accessory with a clean rag to remove all dust, dirt or grease. Use masking tape to outline the area to be covered with adhesive to ensure neat installation and a true bond line.

Do not allow adhesive to contact the face surface of the accessories or the vinyl wall covering beyond the masking tape line. Allow all adhesive to dry properly according to the adhesive manufacturer's recommendations. Because contact adhesive will bond immediately (and only to itself) upon contact, use of slip sheets is recommended to prevent accidental bonding.

Immediately upon successful installation, remove all masking tape and any excessive adhesive from the vinyl wall covering and the accessory.

Other Accessories

CORNER GUARDS

- 1 Only use a non-flammable, solvent-based contact adhesive. A water-based adhesive won't provide an adequate bond for the vinyl.
- 2 Use a small brush to apply an even coat of adhesive to the wall surface within the masking tape outline and to the back of the vinyl corner guard. Make sure you achieve full coverage.
- 3 Carefully align the corner guard within the masking tape outline and press firmly into place. Roll the entire corner guard using a high-pressure roller.

DOOR FRAME PROTECTORS

- 1 Use a water-based contact adhesive to bond vinyl wall covering accessories to painted metal or wood doors.
- 2 Use a small trim brush to apply an even coat of adhesive to the doorframe surface within the masking tape outline and to the back of the doorframe guard. Make sure you achieve full coverage.
- 3 Carefully align the door-frame guard within the masking tape outline and press firmly into place. Roll the entire doorframe guard using a high-pressure roller.

KICKPLATES/ PUSHPLATES

- 1 In many cases, a water-based contact adhesive will bond vinyl wall covering accessories to painted metal or wood doors.
- 2 Use a roller or brush to apply an even coat of adhesive to the door surface within the masking tape outline and to the back of the kickplate/pushplate. Be sure you achieve full coverage.
- 3 Carefully align the kickplate/pushplate within the masking tape outline and press firmly into place. Roll the entire kickplate/pushplate using a high-pressure roller.

Care and Cleaning Instructions

AFTER INSTALLATION

ALWAYS FOLLOW THE DIRECTIONS FROM THE ADHESIVE MANUFACTURER TO CLEAN UP AND/OR REMOVE EXCESS ADHESIVE. To prevent possible staining of wall covering, it's important to remove any adhesive residue and/or other dirt immediately upon completion of installation of sheets. Use mineral spirits, naphtha, or a specific solvent recommended by the adhesive manufacturer and follow the directions carefully. Rinse the cleaned area immediately with warm soapy water, then rinse with clean water and dry with a soft cloth.

General Maintenance

Do not use an ammonia based cleaner, powdered cleaners or bleach; they can leave a residue if not rinsed properly. Use a liquid cleaner (such as SoftScrub without bleach, Fantastic, 409, etc.) on a sponge or a soft cloth; use a stiff bristle brush to remove heavy dirt from the textured surface if necessary. Always rinse with clean water and dry with a soft cloth.

For heavy-duty cleaning (graffiti, etc.) use a stronger cleaning agent such as "Crown Anti-Vandal Spray" or the equivalent. Follow the same procedures noted above, always rinsing all areas thoroughly in clean water and drying completely.

High-pressure water can also be used to clean wall covering surface. Make sure that all seams and joints are completely sealed and do not spray high-pressure water directly on caulked seams or joints. Do not use water with extremely high temperature and do not use steam to clean vinyl wall covering because it may cause blistering and/or warping.

IMPORTANT NOTE

WallGuard.com offers the data and suggestions in this booklet in good faith and as general guidelines only. There is no guarantee specified or implied because WallGuard.com cannot control the conditions and installation methods concerning the vinyl wall covering products.

Because each installation is unique, it is recommended that you determine the suitability of the materials, adhesives, tools and the installation methods according to the needs of your specific location and process before beginning installation.

WallGuard.com welcomes your feedback. Please direct all questions or comments directly to our Customer Service Department at 1-877-943-6826. Thank you for your interest in WallGuard.com.

Cleaning excess adhesive before it dries is easier and increases the likelihood of complete removal of the adhesive.

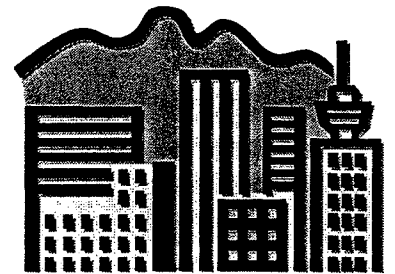

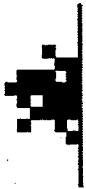

New Frontier Series 2400

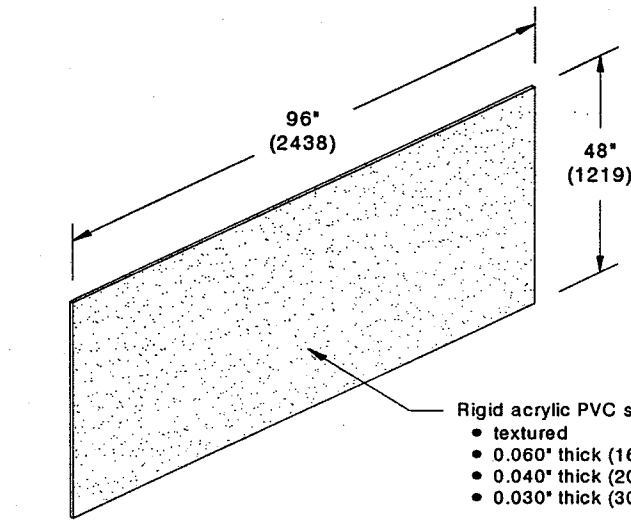

Features:

- Class A fire rating
- Heavier gauges available
- Stock size 4'-0" (1219) x 8'-0" (2438) sheets
- Custom sizes are available (minimums apply)

Finishes:

- 50 Standard colors for 0.060"
- 30 Standard colors for 0.040" and 0.030"
- 20 additional colors available for 0.040" and 0.030" with 2 case minimum
- Custom colors available

Mounting Options:

- Adhesive adhesive supplied separately

0.060"
0.040"
0.030"

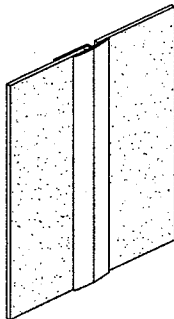

Joint cover

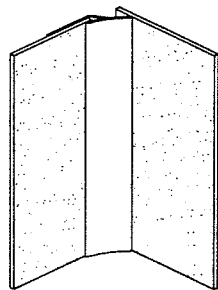

Inside corner (90 to 135 degrees)

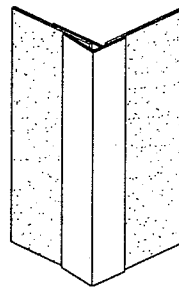

Outside corner

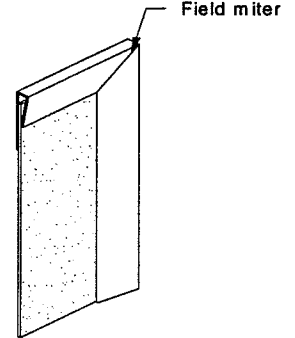

Top cap/End cap